

CREATE
YOUR STYLE
with SWAROVSKI ELEMENTS

DESIGN PROJECT
SUMMER HOLIDAY
NECKLACE
OCEAN



NECKLACE "OCEAN"



SWAROVSKI ELEMENTS

Article	Product Group	Article No.	Amount	Size	Colour	Colour Code
	Fancy Stones	4127	1 pc.	30x22 mm	Crystal Vitrail Medium	001 VM
	Fancy Stones	4437	1 pc.	14 mm	Crystal Bermuda Blue	001 BBL
	Fancy Stones	4437	1 pc.	20 mm	Crystal Bermuda Blue	001 BBL
	Beads	5000	9 pcs.	4 mm	Turquoise	267
	Beads	5000	77 pcs.	6 mm	Turquoise	267
	Beads	5000	114 pcs.	8 mm	Caribbean Blue Opal	394
	Beads	5139	1 pc.	12 mm	Light Topaz	226
	Beads	5328	3 pcs.	4 mm	Turquoise	267
	Beads	5328	79 pcs.	6 mm	Turquoise	267
	Beads	5328	1 pc.	8 mm	Fern Green	291
	Beads	5523	1 pc.	12 mm	Olivine	228
	Beads	5727	1 pc.	18 mm	Capri Blue	243
	Pendants	6690	1 pc.	23 mm	Fuchsia	505
	Pendants	6721	1 pc.	20 mm	Indicolite	379
	Pendants	6790	1 pc.	30 mm	Amethyst	204

Supplies & Tools

Supplies
 1x Setting: 4127/S H2 O, gold, 30x22mm
 2x Crimping tubes, gold, 2x1.8 mm
 22x Jump ring, gold, Ø 5 mm
 3x Jump ring, gold, Ø 7 mm
 1x Jump ring, gold, Ø 12 mm
 5x Head pins, gold
 2.4 m Tiger tail, grey, Ø 0.46 mm

Tools
 Crimping pliers
 Flat nose pliers
 Round nose pliers
 Side cutter
 Tweezers

Level of design: INTERMEDIATE

Have also a look at the **text instruction** at the last page!

STEP 1

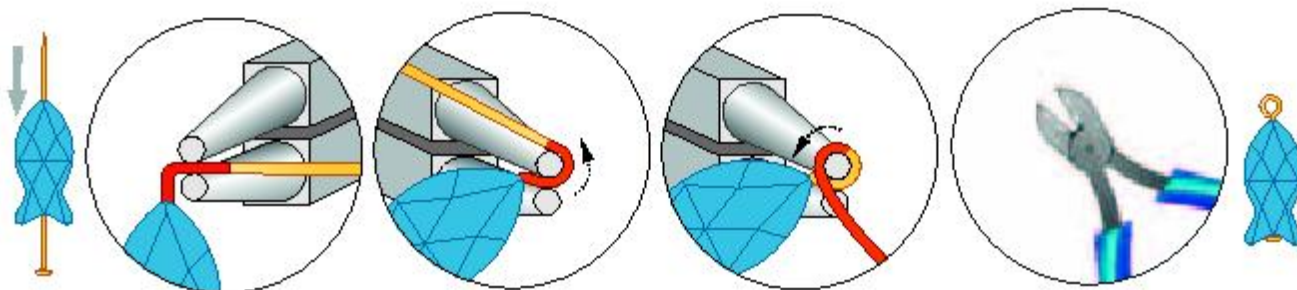

Repeat x3:



STEP 2

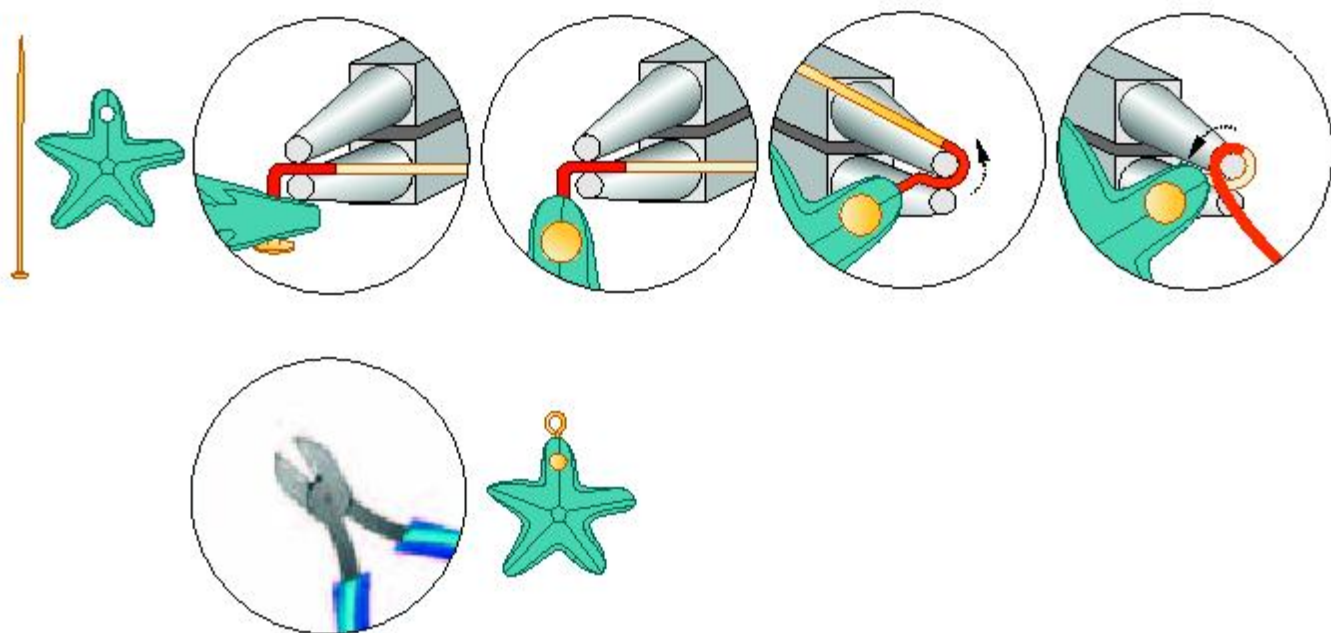

STEP 3

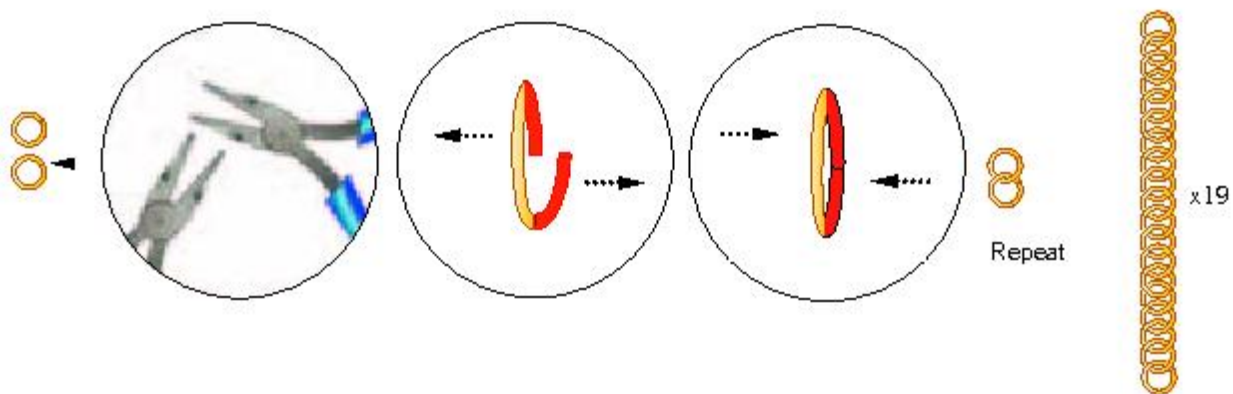

STEP 4

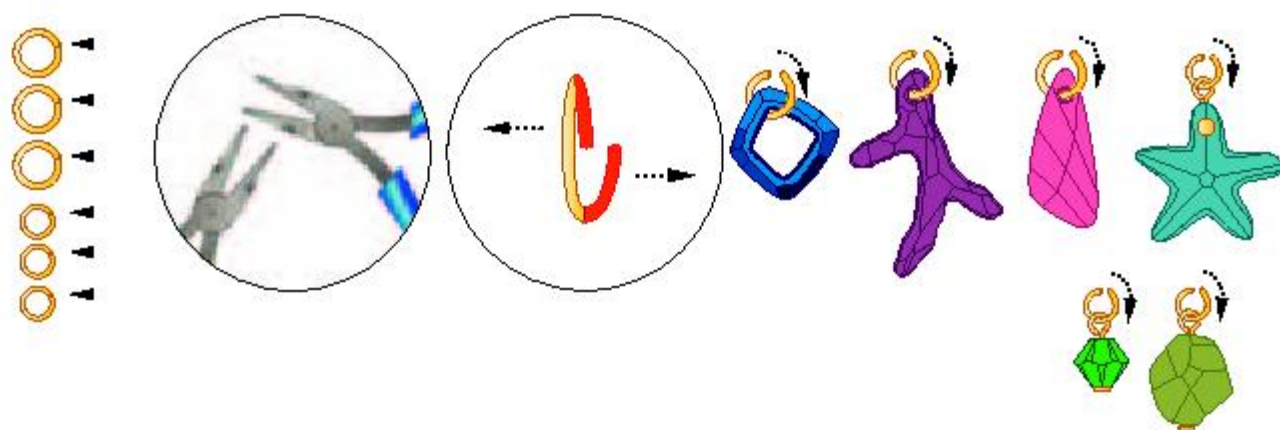

STEP 5

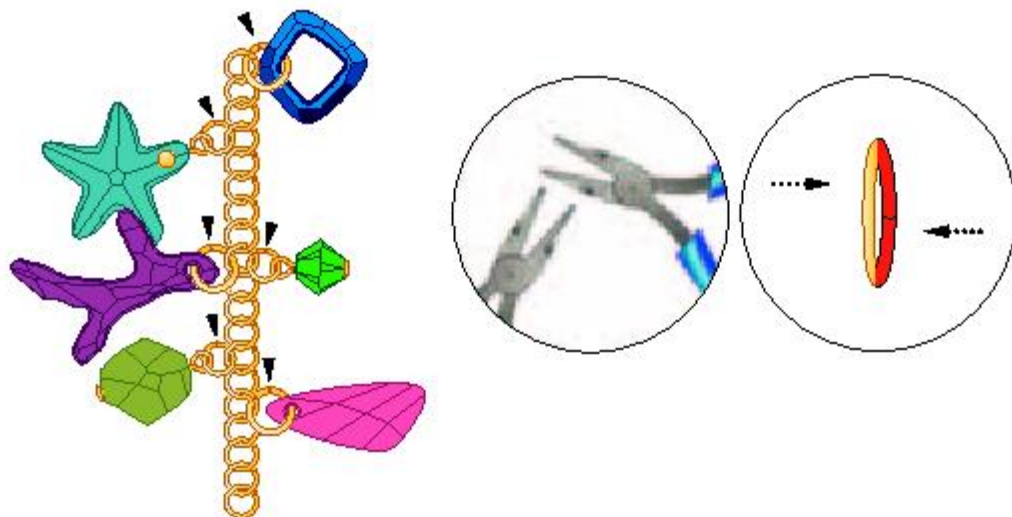

STEP 6

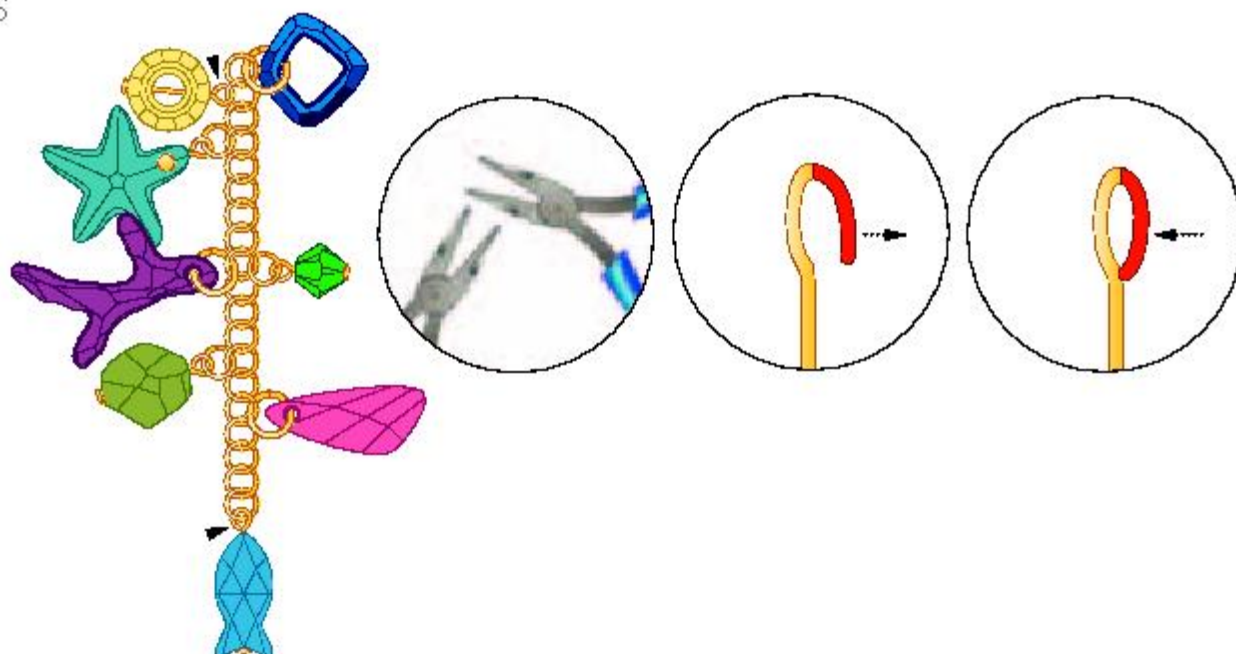

STEP 7

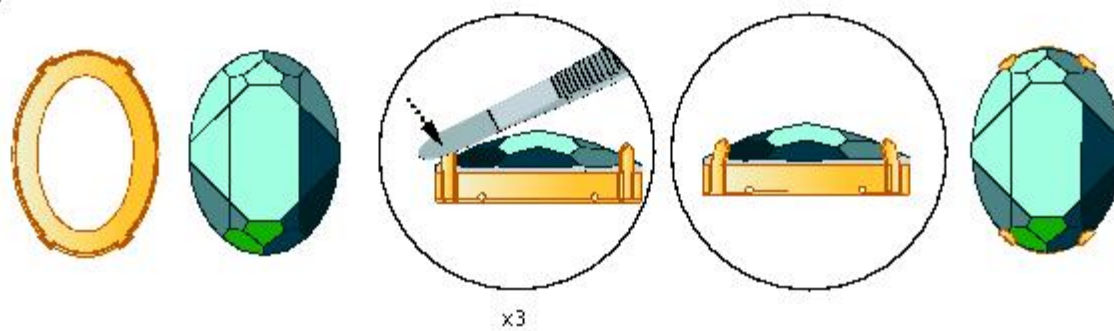

STEP 8

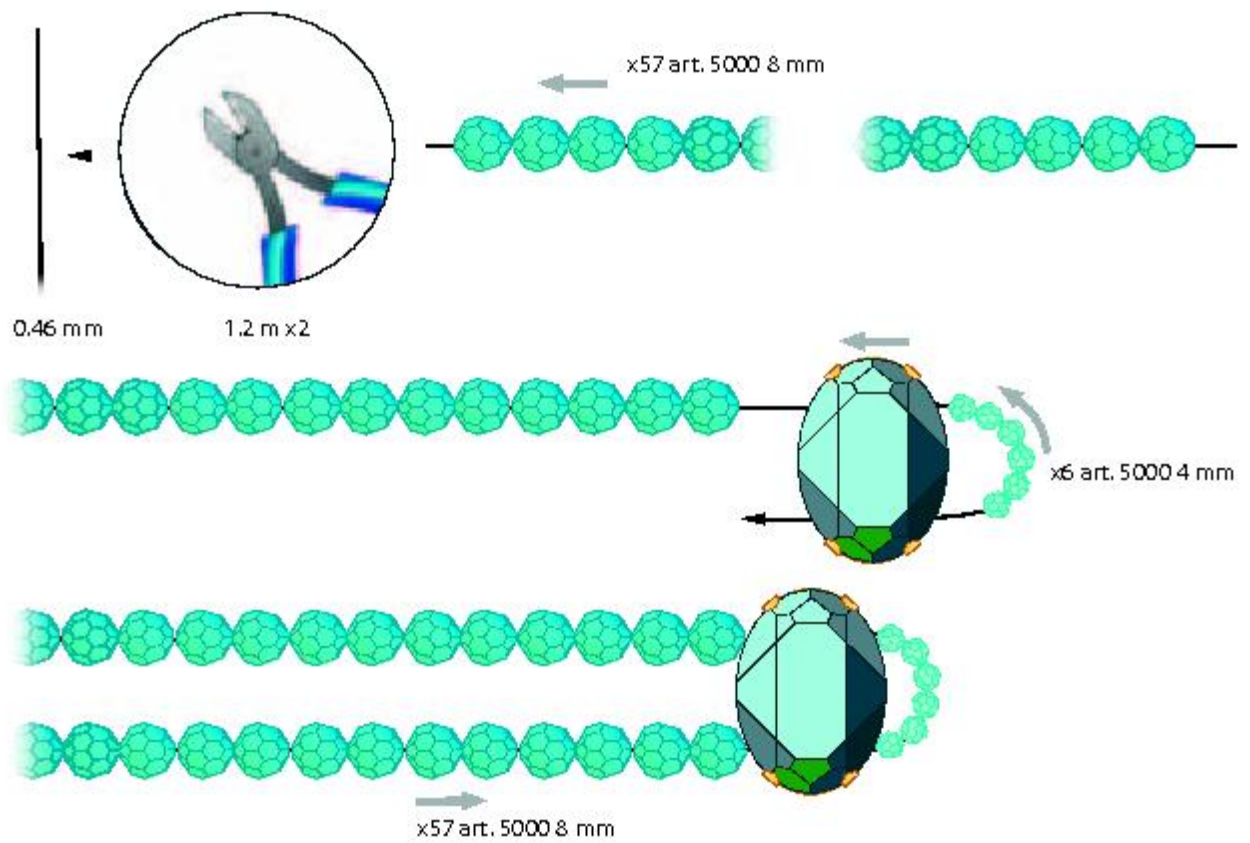

STEP 9

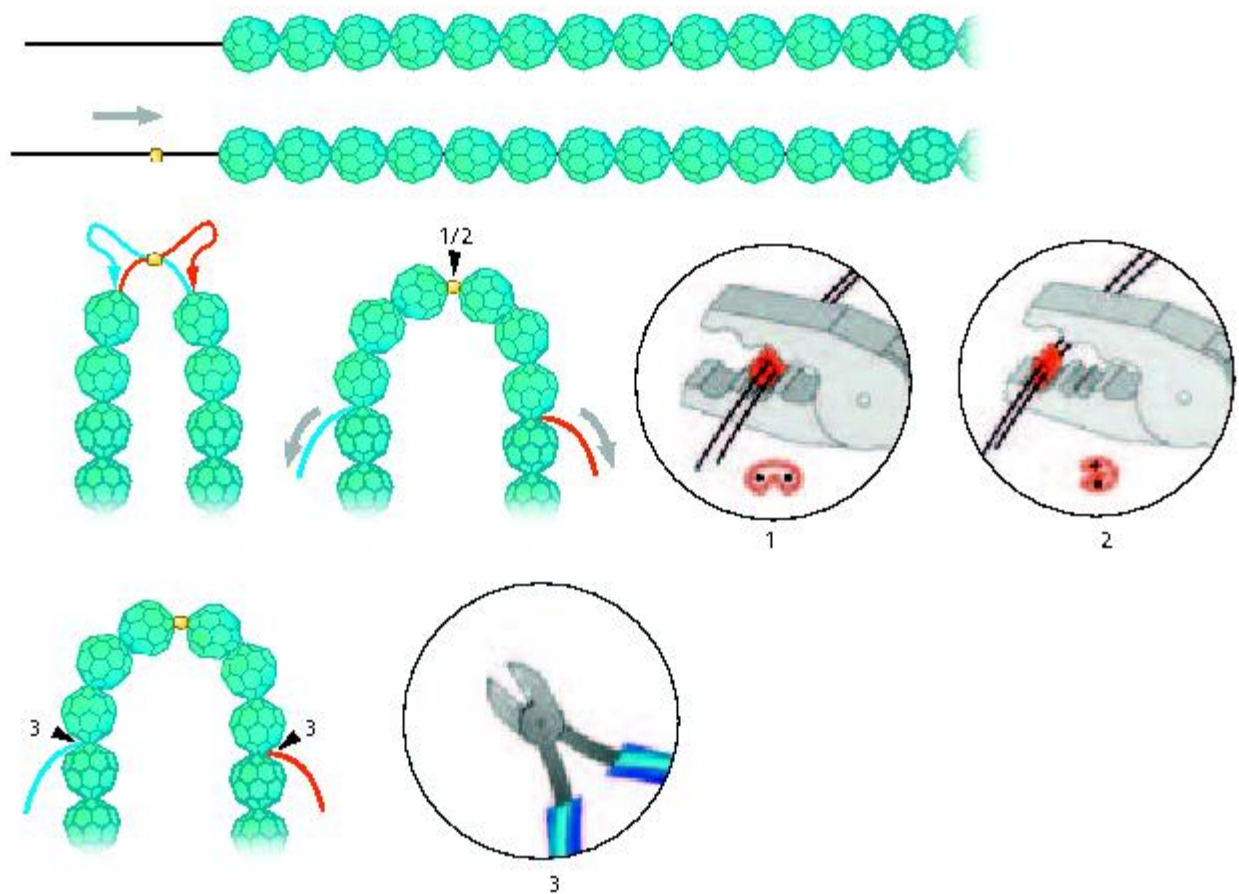

STEP 10

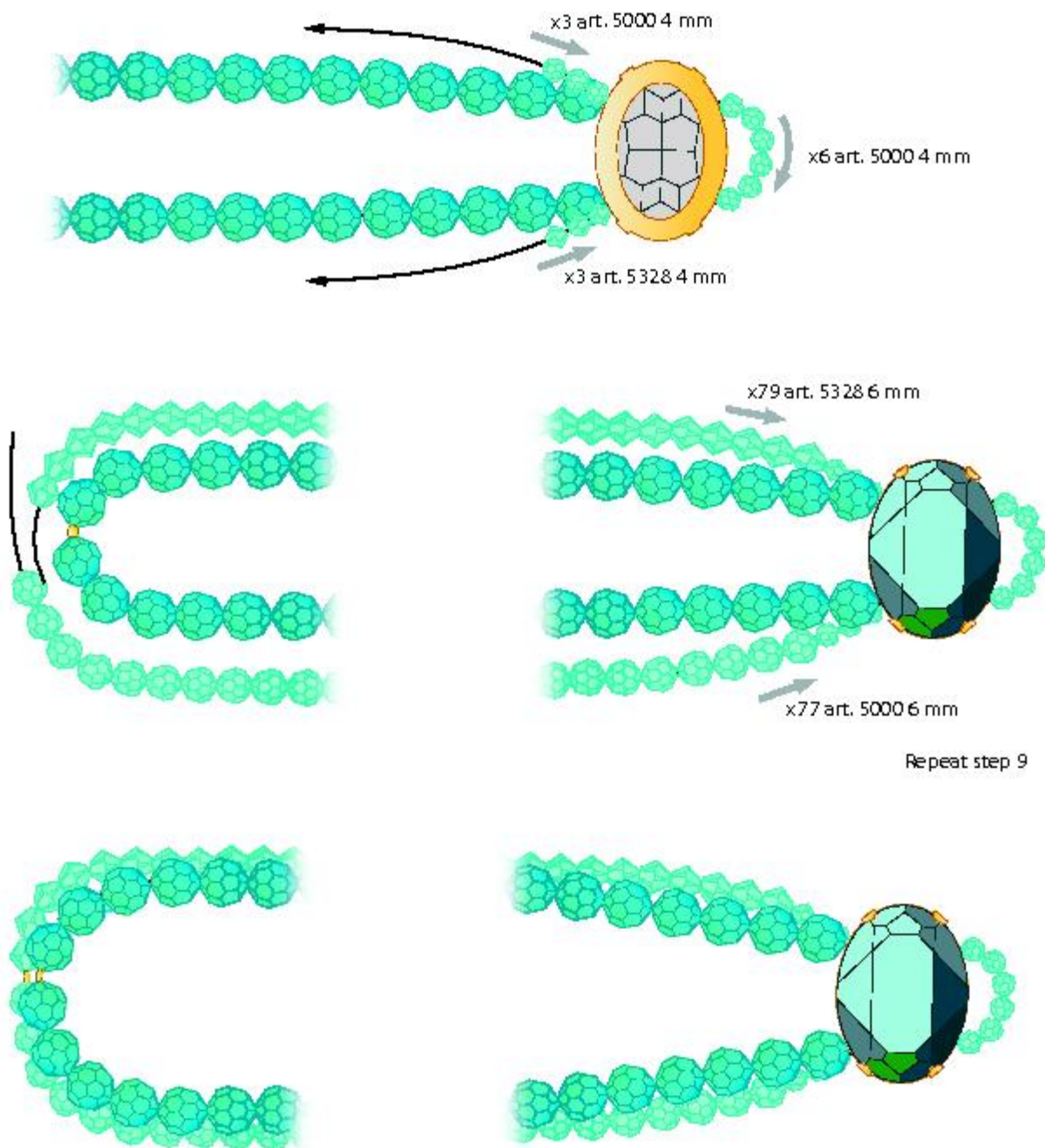

STEP 11

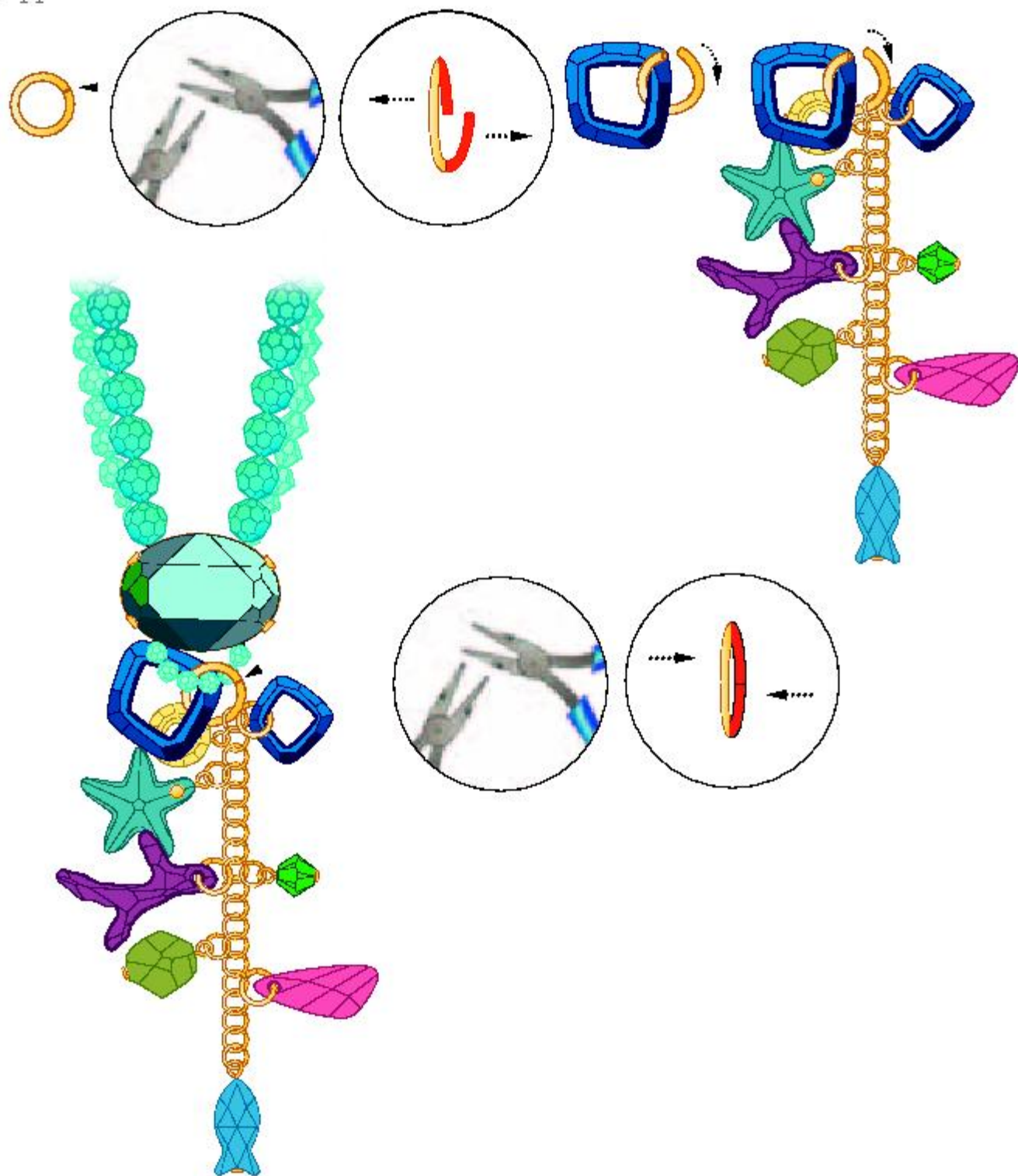



scale 1:2

CREATE YOUR STYLE Design Project

Summer Holiday Necklace "Ocean"

- STEP 1: Slide Bead article 5727 from the SWAROVSKI ELEMENTS assortment onto headpin and bend a loop as shown in illustration. Repeat step with other Swarovski Beads: 5328 Fern Green, 5139 Light Topaz and 5523 Olivine.
- STEP 2: Slide Swarovski Starfish Pendant article 6721 onto headpin and bend the head pin up as you see in first magnifier in illustration. Then bend a loop as shown in illustration.
- STEP 3: Open a 5mm jump ring, insert a second 5mm jump ring and close jump ring with flat nose pliers. Repeat step until you have a chain with 19 jump rings.
- STEP 4: Open three 7mm jump rings and insert the following SWAROVSKI ELEMENTS: 4437 14mm, 6790 30mm and 6690 23mm. Then open three 5mm jump rings and insert the crystals with headpins from Step 1 and 2: 6721 20mm, 5328 8mm and 5523 12mm.
- STEP 5: Hang these SWAROVSKI ELEMENTS with jump rings into Chain as depict in illustration and close jump rings with flat nose pliers.
- STEP 6: Open the loops on the Swarovski Fish Bead and Ring Bead on head pins and insert these also in chain as you see in illustration. Then close loops.
- STEP 7: Put the Swarovski Fancy Stone article 4127 into setting. Press the prongs down softly with back side of tweezers to hold crystal in place.
- STEP 8: Cut 1.2 m of 0.46mm tiger tail and slide on 57 Swarovski Beads article 5000 6mm. Go through holes of setting and slide on 6 Swarovski Beads article 5000 4mm, go through the other 2 holes of setting and slide on 57 more Swarovski Beads article 5000 6mm as shown in illustration.
- STEP 9: Slide a crimping tube onto one tiger tail end, cross tiger tail ends in crimping tube, go back with each tail end through last 3 Swarovski Beads article 5000 4mm, crimp the crimping tube correctly as shown in illustration and cut off tiger tail pieces with side cutter.
- STEP 10: Turn setting around, insert 2nd piece of tiger tail from back side of setting through holes, slide on Swarovski Beads article 5000 4mm (please refer to illustration), go through other holes of setting and slide on 3 Swarovski Beads article 5328 4mm as you see in illustration. Repeat step 9 for sliding on and crimping the crimping tube.
- STEP 11: Open the 12mm jump ring with flat nose pliers, hang the Swarovski Fancy Stone article 4437 20mm and close jump ring around a 5mm jump ring and around loop under setting as you see in illustration.